

	Air Filter		Rev.	Date	Prepared By	Checked By	Approved By
			1	2019.09.20	LEE.S.M.	JO.S.J.	KIM.H.W.
	Particulate Type		2	2020.09.23	WOO.I.H.	JO.S.J.	KIM.H.W.
			3				
4							
Project Name			-		Model Name		HYF-40-20AN
SPECIFICATION							
2	Element Type	Particulate		Inlet Flow Rate	1.7	Nm3/min	
3	Element Quantity	1	EA	Inlet Pressure	7	barg	
4	Element Filtration	40	micron	Inlet Temp.	38	°C	
5		-	ppm	Outlet Flow Rate	1.7	Nm3/min	
6	Element Design Temp.	65	°C	Outlet Pressure	6.8	barg	
7	Flow Direction	Outside to Inside		Outlet Temp.	38	°C	
8	Design Code	Maker STD.		Pressure Drop	0.2	bar	
9	Auto Drain	HAD-10		Design Pressure	14	barg	
10				Design Temperature	100	°C	
CONSTRUCTION							
12	Inlet Connection	20A	PT Female Screw	Dimension (W x L)	85 X 225	mm	
13	Outlet Connection	20A	PT Female Screw	Weight	1.0	kg	
14	Drain Connection	15A	PT Female Screw	Color (Munsell)	5.7PB 4.1/9.9		
MATERIALS							
16	Head	ALDC					
17	Bowl	ALDC					
18	O-Ring	N.B.R.					
19	Element	Polyethylene					
20							
21							
STANDRAD FEATURES AND CONTROL							
23	Pressure Gauge	NO					
24	Differential Indicator	YES					
25	Differential Transmitter	NO					
26	Auto Drain	YES					
NOTES							
28							
29							
30							
31							
32							
33							
34							
35							
36							
37							
38							
39							
40							
41							
42							
43							
44							
45							

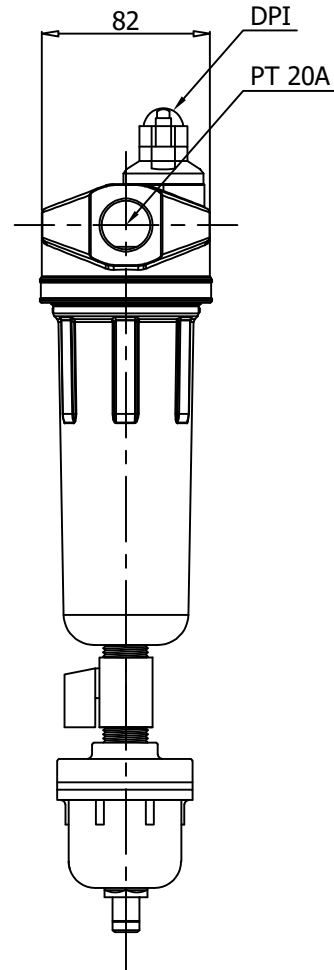
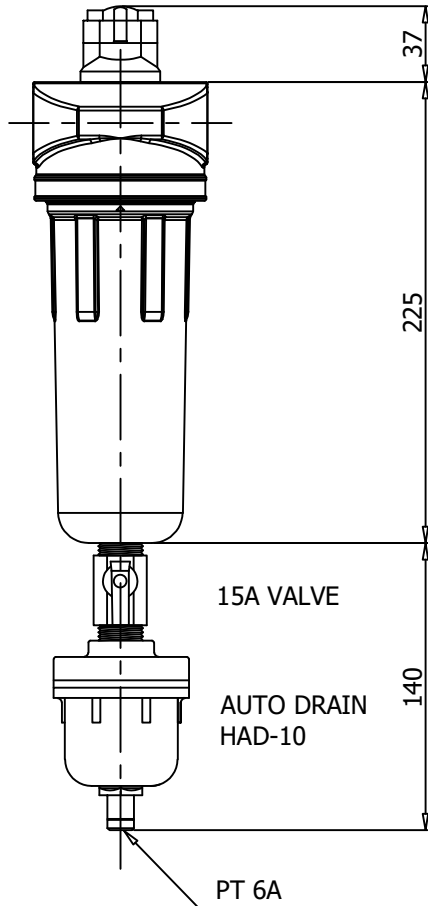
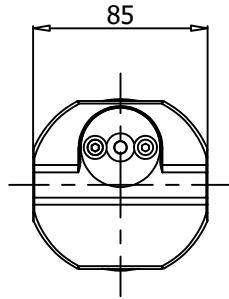

MODEL	HYF-40-20AN
CAPACITY	1.7 Nm ³ /min
INLET AIR TEMPERATURE	MAX. 65 °C
MAX. INLET AIR PRESSURE	14 barg
ELEMENT TYPE	PARTICULATE
FILTRATION	40 MICRON
IN/OUT CONNECTION	PT 20A
FLOW DIRECTION	OUTSIDE TO INSIDE

△										
△										
△										
△										
△	2020.09.24	ISSUED FOR PROPOSAL								
REV. NO.	DATE	DESCRIPTION	DWG.	CHK.	APPD.	APPD.	APPD.			
PROJECT										
MANUFACTURER										
										
TITLE										
HYF-40-20AN OUTLINE										
ITEM NO.	HYF-20AN	DWG NO.								REV.
SCALE	NONE	GSA-HYF-020AN-01							△	

	Air Filter	Rev.	Date	Prepared By	Checked By	Approved By
		1	2019.09.20	LEE.S.M.	JO.S.J.	KIM.H.W.
	Particulate Type	2	2020.09.23	WOO.I.H.	JO.S.J.	KIM.H.W.
		3				
4						

Project Name	-	Model Name	HYF-5-20AN
--------------	---	------------	------------

1 SPECIFICATION					
2	Element Type	Particulate		Inlet Flow Rate	1.7 Nm3/min
3	Element Quantity	1	EA	Inlet Pressure	7 barg
4	Element Filtration	5	micron	Inlet Temp.	38 °C
5		-	ppm	Outlet Flow Rate	1.7 Nm3/min
6	Element Design Temp.	65	°C	Outlet Pressure	6.8 barg
7	Flow Direction	Outside to Inside		Outlet Temp.	38 °C
8	Design Code	Maker STD.		Pressure Drop	0.2 bar
9	Auto Drain	HAD-10		Design Pressure	14 barg
10				Design Temperature	100 °C

11 CONSTRUCTION					
12	Inlet Connection	20A	PT Female Screw	Dimension (W x L)	85 X 225 mm
13	Outlet Connection	20A	PT Female Screw	Weight	1.0 kg
14	Drain Connection	15A	PT Female Screw	Color (Munsell)	5.7PB 4.1/9.9

15 MATERIALS					
16	Head	ALDC			
17	Bowl	ALDC			
18	O-Ring	N.B.R.			
19	Element	Polyethylene			
20					
21					

22 STANDRAD FEATURES AND CONTROL					
23	Pressure Gauge	NO			
24	Differential Indicator	YES			
25	Differential Transmitter	NO			
26	Auto Drain	YES			

27 NOTES					
28					
29					
30					
31					
32					
33					
34					
35					
36					
37					
38					
39					
40					
41					
42					
43					
44					
45					

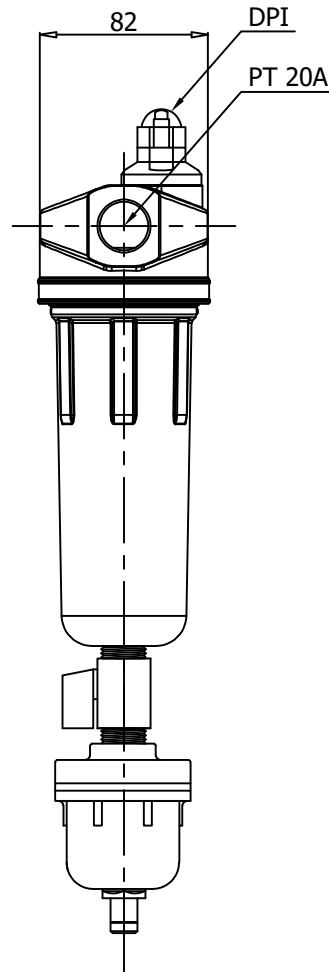
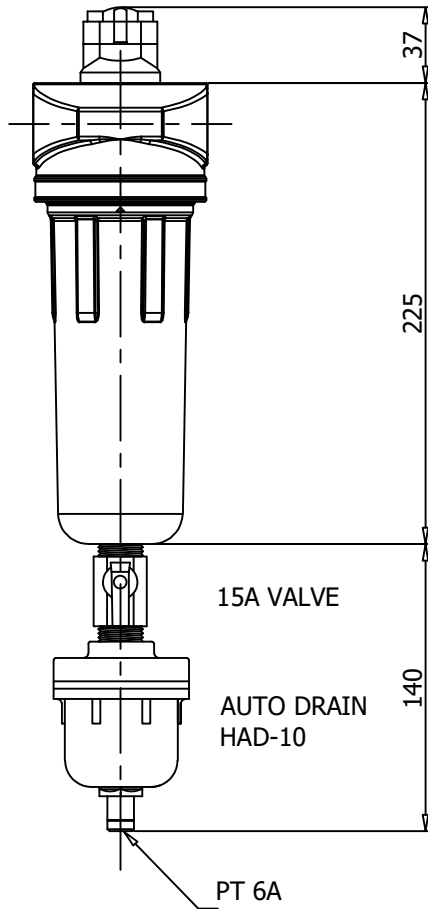
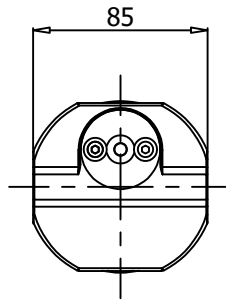

MODEL	HYF-5-20AN
CAPACITY	1.7 Nm ³ /min
INLET AIR TEMPERATURE	MAX. 65 °C
MAX. INLET AIR PRESSURE	14 barg
ELEMENT TYPE	PARTICULATE
FILTRATION	5 MICRON
IN/OUT CONNECTION	PT 20A
FLOW DIRECTION	OUTSIDE TO INSIDE

△											
△											
△											
△											
△	2020.09.24	ISSUED FOR PROPOSAL									
REV. NO.	DATE	DESCRIPTION	DWG.	CHK.	APPD.	APPD.	APPD.				
PROJECT											
MANUFACTURER											
											
TITLE											
HYF-5-20AN OUTLINE											
ITEM NO.	HYF-20AN	DWG NO.	GSA-HYF-020AN-02							REV.	△
SCALE	NONE										

	Air Filter	Rev.	Date	Prepared By	Checked By	Approved By
		1	2019.09.20	LEE.S.M.	JO.S.J.	KIM.H.W.
	Coalescer Type	2	2020.09.23	WOO.I.H.	JO.S.J.	KIM.H.W.
		3				
4						

Project Name	-	Model Name	HYF-1-20AN
--------------	---	------------	------------

1	SPECIFICATION				
2	Element Type	Coalescer		Inlet Flow Rate	1.7 Nm3/min
3	Element Quantity	1	EA	Inlet Pressure	7 barg
4	Element Filtration	1	micron	Inlet Temp.	38 °C
5		1	ppm	Outlet Flow Rate	1.7 Nm3/min
6	Element Design Temp.	54	°C	Outlet Pressure	6.8 barg
7	Flow Direction	Inside to Outside		Outlet Temp.	38 °C
8	Design Code	Maker STD.		Pressure Drop	0.2 bar
9	Auto Drain	HAD-10		Design Pressure	14 barg
10				Design Temperature	100 °C
11	CONSTRUCTION				
12	Inlet Connection	20A	PT Female Screw	Dimension (W x L)	85 X 225 mm
13	Outlet Connection	20A	PT Female Screw	Weight	1.0 kg
14	Drain Connection	15A	PT Female Screw	Color (Munsell)	5.7PB 4.1/9.9
15	MATERIALS				
16	Head	ALDC			
17	Bowl	ALDC			
18	O-Ring	N.B.R.			
19	Element	Borosilicate			
20					
21					
22	STANDRAD FEATURES AND CONTROL				
23	Pressure Gauge	NO			
24	Differential Indicator	YES			
25	Differential Transmitter	NO			
26	Auto Drain	YES			
27	NOTES				
28					
29					
30					
31					
32					
33					
34					
35					
36					
37					
38					
39					
40					
41					
42					
43					
44					
45					

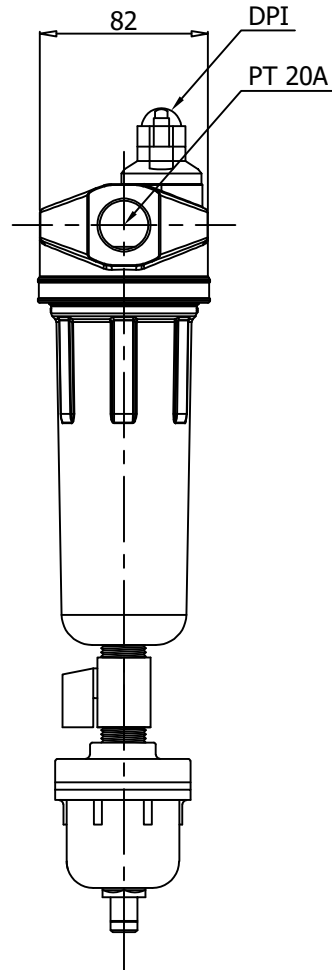
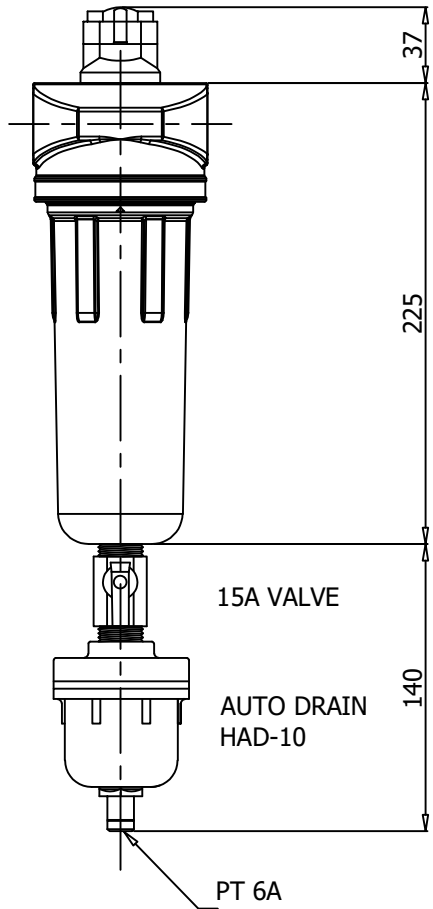
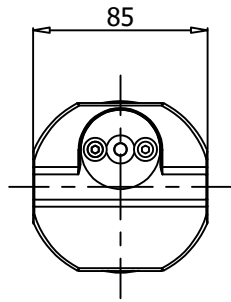

MODEL	HYF-1-20AN
CAPACITY	1.7 Nm ³ /min
INLET AIR TEMPERATURE	MAX. 54 °C
MAX. INLET AIR PRESSURE	14 barg
ELEMENT TYPE	COALESCER
FILTRATION	1 MICRON
	1 PPM
IN/OUT CONNECTION	PT 20A
FLOW DIRECTION	INSIDE TO OUTSIDE

△											
△											
△											
△											
△	2020.09.24	ISSUED FOR PROPOSAL									
REV. NO.	DATE	DESCRIPTION	DWG.	CHK.	APPD.	APPD.	APPD.				
PROJECT											
MANUFACTURER											
											
TITLE											
HYF-1-20AN OUTLINE											
ITEM NO.	HYF-20AN	DWG NO.	GSA-HYF-020AN-03							REV.	△
SCALE	NONE										

	Air Filter	Rev.	Date	Prepared By	Checked By	Approved By
		1	2019.09.20	LEE.S.M.	JO.S.J.	KIM.H.W.
	Coalescer Type	2	2020.09.23	WOO.I.H.	JO.S.J.	KIM.H.W.
		3				
4						

Project Name	-	Model Name	HYF-0.1-20AN
--------------	---	------------	--------------

SPECIFICATION					
2	Element Type	Coalescer		Inlet Flow Rate	1.7 Nm3/min
3	Element Quantity	1	EA	Inlet Pressure	7 barg
4	Element Filtration	1	micron	Inlet Temp.	38 °C
5		0.1	ppm	Outlet Flow Rate	1.7 Nm3/min
6	Element Design Temp.	54	°C	Outlet Pressure	6.8 barg
7	Flow Direction	Inside to Outside		Outlet Temp.	38 °C
8	Design Code	Maker STD.		Pressure Drop	0.2 bar
9	Auto Drain	HAD-10		Design Pressure	14 barg
10				Design Temperature	100 °C

CONSTRUCTION					
12	Inlet Connection	20A	PT Female Screw	Dimension (W x L)	85 X 225 mm
13	Outlet Connection	20A	PT Female Screw	Weight	1.0 kg
14	Drain Connection	15A	PT Female Screw	Color (Munsell)	5.7PB 4.1/9.9

MATERIALS					
16	Head	ALDC			
17	Bowl	ALDC			
18	O-Ring	N.B.R.			
19	Element	Borosilicate			
20					
21					

STANDRAD FEATURES AND CONTROL					
23	Pressure Gauge	NO			
24	Differential Indicator	YES			
25	Differential Transmitter	NO			
26	Auto Drain	YES			

NOTES					
28					
29					
30					
31					
32					
33					
34					
35					
36					
37					
38					
39					
40					
41					
42					
43					
44					
45					

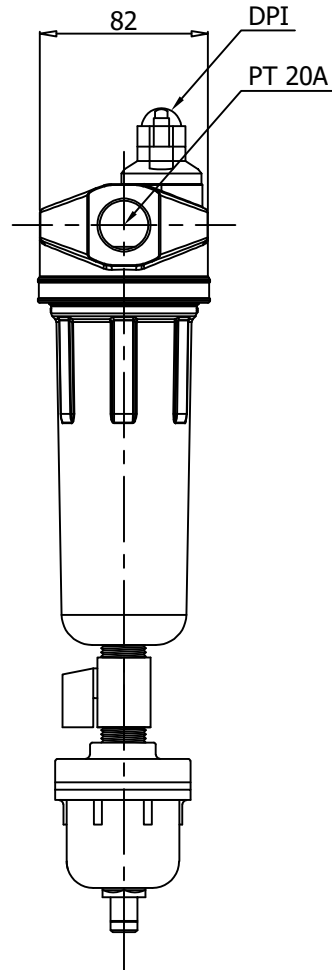
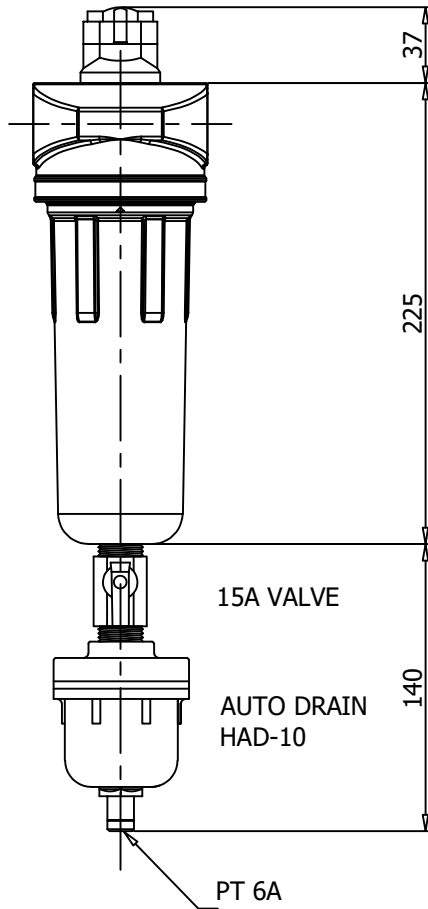
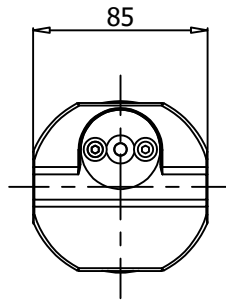

MODEL	HYF-0.1-20AN
CAPACITY	1.7 Nm ³ /min
INLET AIR TEMPERATURE	MAX. 54 °C
MAX. INLET AIR PRESSURE	14 barg
ELEMENT TYPE	COALESCER
FILTRATION	1 MICRON
	0.1 PPM
IN/OUT CONNECTION	PT 20A
FLOW DIRECTION	INSIDE TO OUTSIDE

△									
△									
△									
△									
△	2020.09.24	ISSUED FOR PROPOSAL							
REV. NO.	DATE	DESCRIPTION	DWG.	CHK.	APPD.	APPD.	APPD.	APPD.	APPD.
PROJECT									
MANUFACTURER									
									
TITLE									
HYF-0.1-20AN OUTLINE									
ITEM NO.	HYF-20AN	DWG NO.							
SCALE	NONE	GSA-HYF-020AN-04							

	Air Filter		Rev.	Date	Prepared By	Checked By	Approved By
			1	2019.09.20	LEE.S.M.	JO.S.J.	KIM.H.W.
	Coalescer Type		2	2020.09.23	WOO.I.H.	JO.S.J.	KIM.H.W.
			3				
4							
Project Name			-		Model Name		HYF-0.01-20AN
1	SPECIFICATION						
2	Element Type	Coalescer		Inlet Flow Rate	1.7	Nm3/min	
3	Element Quantity	1	EA	Inlet Pressure	7	barg	
4	Element Filtration	1	micron	Inlet Temp.	38	°C	
5		0.01	ppm	Outlet Flow Rate	1.7	Nm3/min	
6	Element Design Temp.	54	°C	Outlet Pressure	6.8	barg	
7	Flow Direction	Inside to Outside		Outlet Temp.	38	°C	
8	Design Code	Maker STD.		Pressure Drop	0.2	bar	
9	Auto Drain	HAD-10		Design Pressure	14	barg	
10				Design Temperature	100	°C	
11	CONSTRUCTION						
12	Inlet Connection	20A	PT Female Screw	Dimension (W x L)	85 X 225	mm	
13	Outlet Connection	20A	PT Female Screw	Weight	1.0	kg	
14	Drain Connection	15A	PT Female Screw	Color (Munsell)	5.7PB 4.1/9.9		
15	MATERIALS						
16	Head	ALDC					
17	Bowl	ALDC					
18	O-Ring	N.B.R.					
19	Element	Borosilicate					
20							
21							
22	STANDRAD FEATURES AND CONTROL						
23	Pressure Gauge	NO					
24	Differential Indicator	YES					
25	Differential Transmitter	NO					
26	Auto Drain	YES					
27	NOTES						
28							
29							
30							
31							
32							
33							
34							
35							
36							
37							
38							
39							
40							
41							
42							
43							
44							
45							

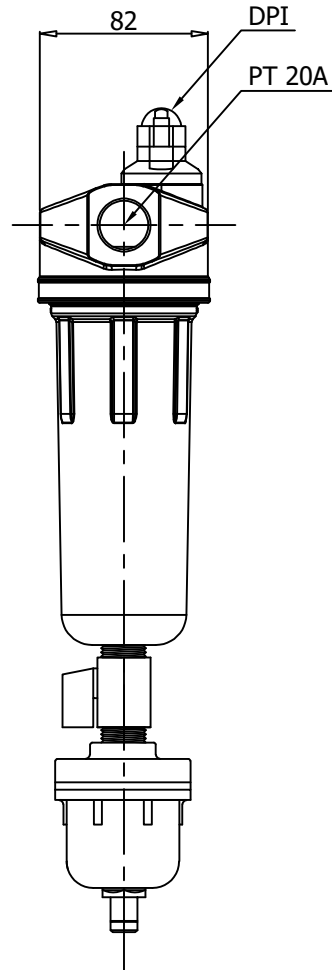
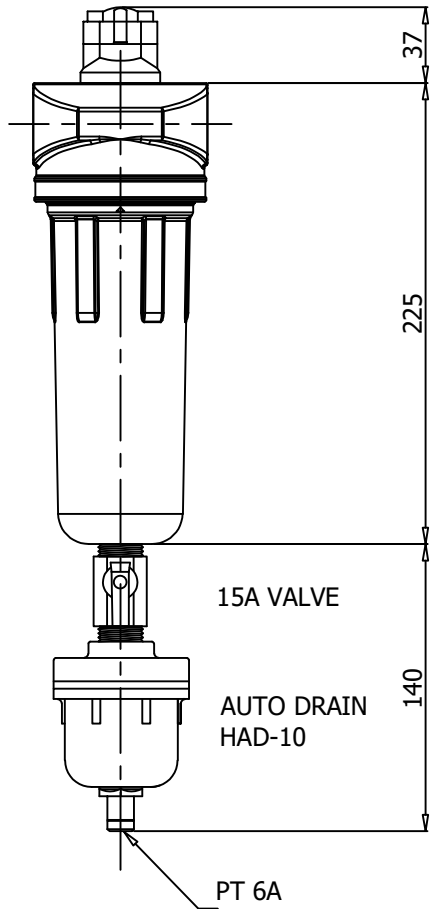
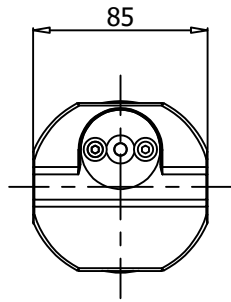

MODEL	HYF-0.01-20AN
CAPACITY	1.7 Nm ³ /min
INLET AIR TEMPERATURE	MAX. 54 °C
MAX. INLET AIR PRESSURE	14 barg
ELEMENT TYPE	COALESCER
FILTRATION	1 MICRON
	0.01 PPM
IN/OUT CONNECTION	PT 20A
FLOW DIRECTION	INSIDE TO OUTSIDE

△										
△										
△										
△										
△	2020.09.24	ISSUED FOR PROPOSAL								
REV. NO.	DATE	DESCRIPTION	DWG.	CHK.	APPD.	APPD.	APPD.			
PROJECT										
MANUFACTURER										
										
TITLE										
HYF-0.01-20AN OUTLINE										
ITEM NO.	HYF-20AN	DWG NO.	GSA-HYF-020AN-05							REV.
SCALE	NONE								△	

	Air Filter	Rev.	Date	Prepared By	Checked By	Approved By
		1	2019.09.20	LEE.S.M.	JO.S.J.	KIM.H.W.
	Coalescer Type	2	2020.09.23	WOO.I.H.	JO.S.J.	KIM.H.W.
		3				
4						

Project Name	-	Model Name	HYF-0.01F-20AN
--------------	---	------------	----------------

1 SPECIFICATION					
2	Element Type	Coalescer		Inlet Flow Rate	1.7 Nm3/min
3	Element Quantity	1	EA	Inlet Pressure	7 barg
4	Element Filtration	1	micron	Inlet Temp.	38 °C
5		0.01	ppm	Outlet Flow Rate	1.7 Nm3/min
6	Element Design Temp.	54	°C	Outlet Pressure	6.8 barg
7	Flow Direction	Inside to Outside		Outlet Temp.	38 °C
8	Design Code	Maker STD.		Pressure Drop	0.2 bar
9	Auto Drain	HAD-10		Design Pressure	14 barg
10				Design Temperature	100 °C
11 CONSTRUCTION					
12	Inlet Connection	20A	PT Female Screw	Dimension (W x L)	85 X 225 mm
13	Outlet Connection	20A	PT Female Screw	Weight	1.0 kg
14	Drain Connection	15A	PT Female Screw	Color (Munsell)	5.7PB 4.1/9.9
15 MATERIALS					
16	Head	ALDC			
17	Bowl	ALDC			
18	O-Ring	N.B.R.			
19	Element	Borosilicate			
20					
21					
22 STANDRAD FEATURES AND CONTROL					
23	Pressure Gauge	NO			
24	Differential Indicator	YES			
25	Differential Transmitter	NO			
26	Auto Drain	YES			
27 NOTES					
28	- Added Carbon Layer				
29					
30					
31					
32					
33					
34					
35					
36					
37					
38					
39					
40					
41					
42					
43					
44					
45					

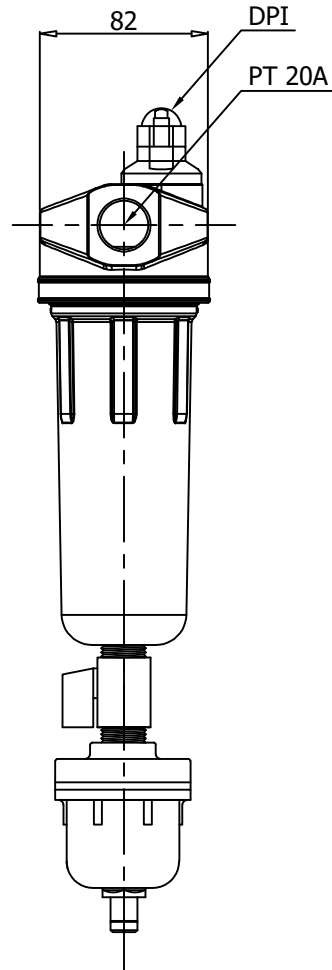
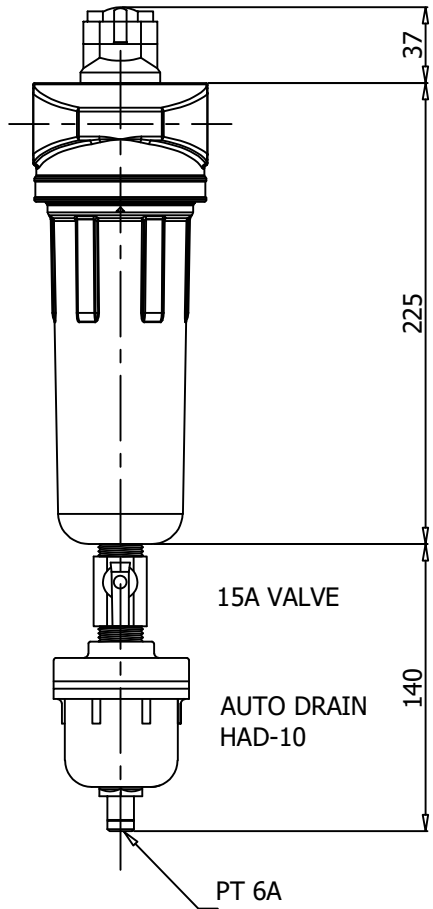
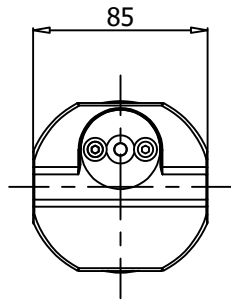

MODEL	HYF-0.01F-20AN
CAPACITY	1.7 Nm ³ /min
INLET AIR TEMPERATURE	MAX. 54 °C
MAX. INLET AIR PRESSURE	14 barg
ELEMENT TYPE	COALESCER
FILTRATION	1 MICRON
	0.01 PPM(Carbon Layer)
IN/OUT CONNECTION	PT 20A
FLOW DIRECTION	INSIDE TO OUTSIDE

△										
△										
△										
△										
△	2020.09.24	ISSUED FOR PROPOSAL								
REV. NO.	DATE	DESCRIPTION	DWG.	CHK.	APPD.	APPD.	APPD.			
PROJECT										
MANUFACTURER										
										
TITLE										
HYF-0.01F-20AN OUTLINE										
ITEM NO.	HYF-20AN	DWG NO.	GSA-HYF-020AN-06							REV.
SCALE	NONE								△	