	Refrigerated Air Dryer		Rev.	Date	Prepared By	Checked By	Approved By
			A	2019.01.15	LEE.S.M.	JO.S.J.	KIM.H.W.
	Air Cooled Type		B				
			C				
D							
Project Name		-		Model Name		HYD-7N	
SPECIFICATION							
1							
2	Supply Voltage	220V	Inlet Flow Rate	0.8	Nm3/min		
3	Phase	1PH	Inlet Pressure	7	barg		
4	Frequency	60Hz	Inlet Temp.	38	°C		
5	Control use	220V	Outlet Flow Rate	0.8	Nm3/min		
6	Fulid	Compressed Air	Outlet Pressure	6.8	barg		
7	Location	Indoor	Outlet Temp.	28±5	°C		
8	Design Code	Maker STD.	Pressure Drop	0.2	bar		
9	Area Class	Non-Hazardous	Outlet Dew Point	2~10	°C		
10			Design Pressure	14	barg		
11			Design Temperature	70	°C		
12			Ambient Temperature	32	°C		
CONSTRUCTION							
13							
14	Refrigerant	R-134A	Dimension (W x L x H)	244 X 554 X 754	mm		
15	Ref. Compressor Type	Recipro Hemertic	Weight	36	kg		
16	Ref. Compressor Capacity	1/5 HP	Power Consumption	0.31	kW		
17	Condenser Type	Air Cooled	Inlet Connection	15A	PT Female Screw		
18	Condenser Fan Motor	9 W	Outlet Connection	15A	PT Female Screw		
19		1 EA	Drain Connection	15A	PT Female Screw		
20	Condenser Fan Size	230 mm	Color (Munsell)	5.7PB 4.1/9.9			
21	Condenser Capacity	1/4 HP		5.7PB 2.9/3.5			
22	Condenser Material	Aluminum & Copper					
23	Heat Exchanger Type	Block					
24	Heat Exchanger Material	Aluminum					
25	Ref. Control Device	Capillary Tube					
26	Temp. Control Device	Hot Gas Bypass Valve					
27	Drain Trap Type	Auto Float					
STANDRAD FEATURES AND CONTROL							
28							
29	Fan Control Switch	YES	Ref. Compressor	YES			
30	Ref. Liquid Filter Dryer	YES	Capillary Tube	YES			
31	Overload Relay	NO	Hot Gas Bypass Valve	YES			
32	PCB Controller	NO	Air Cooled Condenser	YES			
33	Fan Motor Test Button	NO	Accumulator	NO			
34	Air Pressure Gauge	NO	Liquid Ref. Receiver	NO			
35	Ref. Pressure Gauge	NO	Oil Separator	NO			
36	High Pressure Switch	NO	Circuit Breaker	NO			
37	Moisture Indicator	NO	Ref. Compressor Heater	NO			
38	Drain	YES					
NOTES							
39							
40							
41							
42							
43							
44							
45							
46							

INLET AIR TEMPERATURE	38°C
AMBIENT TEMPERATURE	32°C
INLET AIR PRESSURE	7 barg
CAPACITY	0.8 Nm ³ /min
IN/OUT CONNECTION	PT 15A
DIMENSION(WXDXH, mm)	244 X 554 X 754
WEIGHT	36 kg
POWER CONSUMPTION	0.33 kW
POWER SUPPLY	220V - 1PH - 60Hz

COOLING AIR DIRECTION

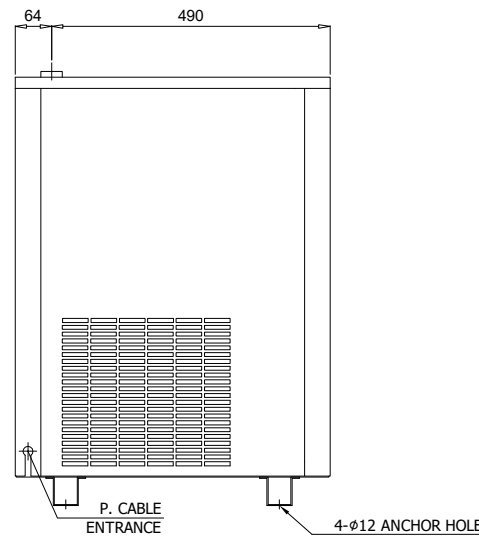
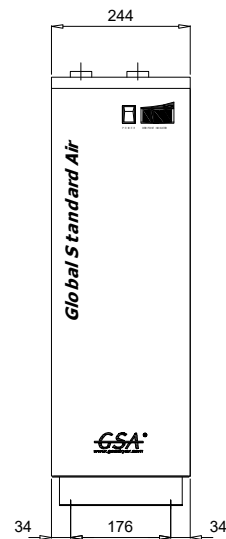
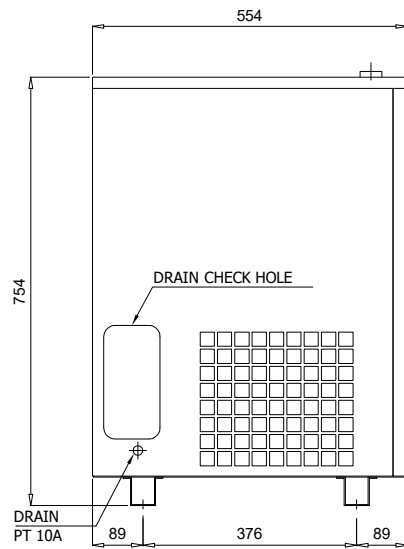
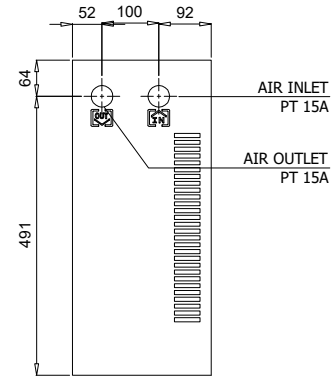
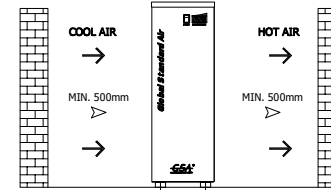

△									
△									
△									
△									
△									
△	2018. 11. 26.	ISSUED FOR REFERENCE							
REV. NO.	DATE	DESCRIPTION	DWG	CHK	APPD	APPD	APPD		
PROJECT									
MANUFACTURER									
TITLE									
OUTLINE DRAWING									
ITEM NO.	HYD-7N	DWG NO.	GSA-HYD-0007N-01				REV.		
SCALE	NONE								

DEW POINT		2~10°C @ PDP	
INLET AIR PRESSURE		7.0 BARG	
INLET AIR TEMPERATURE		38°C	
CAPACITY		0.8 Nm³/min	
9	CAPILLARY TUBE	-	1
8	HGBV	-	1
7	AUTO DRAIN	IN : PT 15A / OUT : 6A	1
6	HEAT EXCHANGER	7 HP	1
5	FILTER DRYER	1/4"	1
4	FAN CONTROLLER	7 ~ 12 BARG	1
3	FAN MOTOR	9W 4P ø230	1
2	A/C CONDENSER	1/4 HP (CONDENSING CAPACITY)	1
1	REF. COMPRESSOR	1/5 HP (COOLING CAPACITY)	1
NO.	PART NAME	DESCRIPTION	QTY

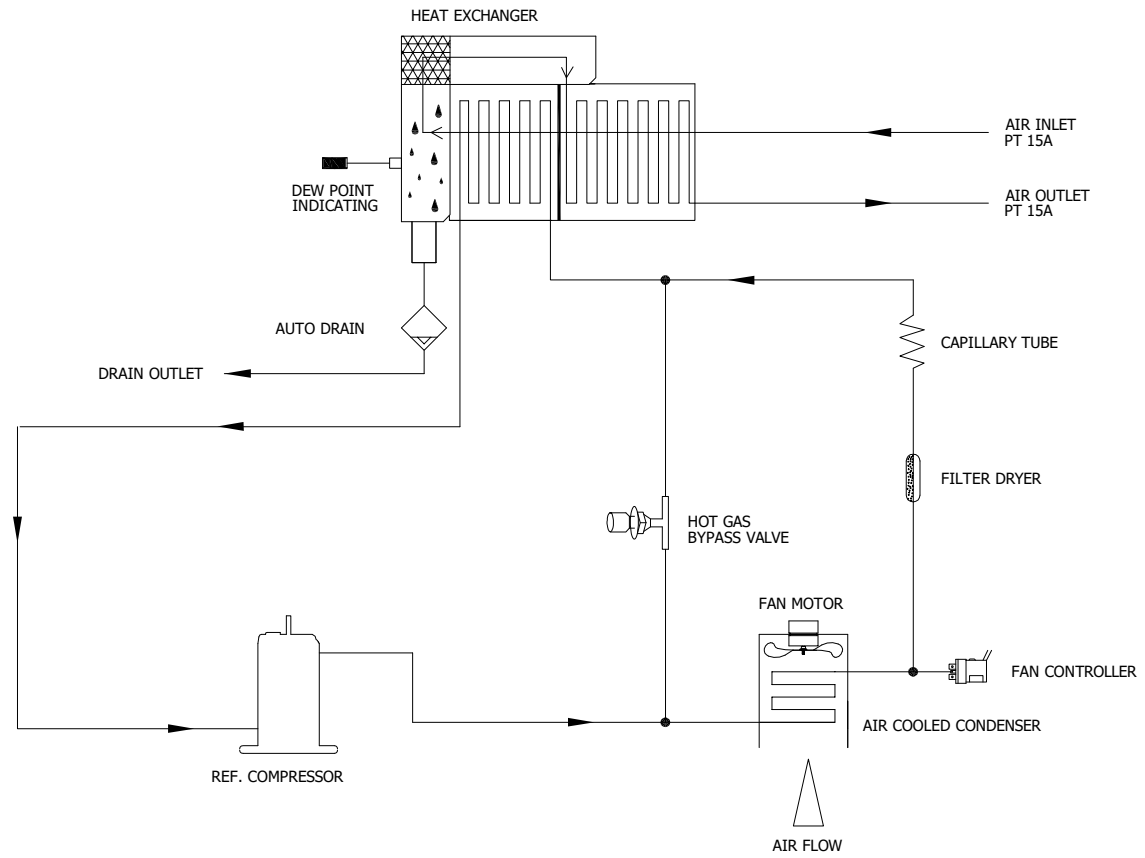

- ← AIR INLET LINE
- AIR OUTLET LINE
- ← REF. LOW PRESS. LINE
- REF. HIGH PRESS. LINE

△											
△											
△											
△	2020. 09. 16.	PARTS NUMBER DELETE									
△	2018. 11. 26.	ISSUED FOR REFERENCE									
REV. NO.	DATE	DESCRIPTION	ENGR	CHK	APPD	APPD	APPD				
PROJECT											
MANUFACTURER											
											
TITLE											
PIPING & INSTRUMENTATION DRAWING											
ITEM NO.	HYD-7N	DWG NO.	GSA-HYD-0007N-02							REV.	△
SCALE	NONE										

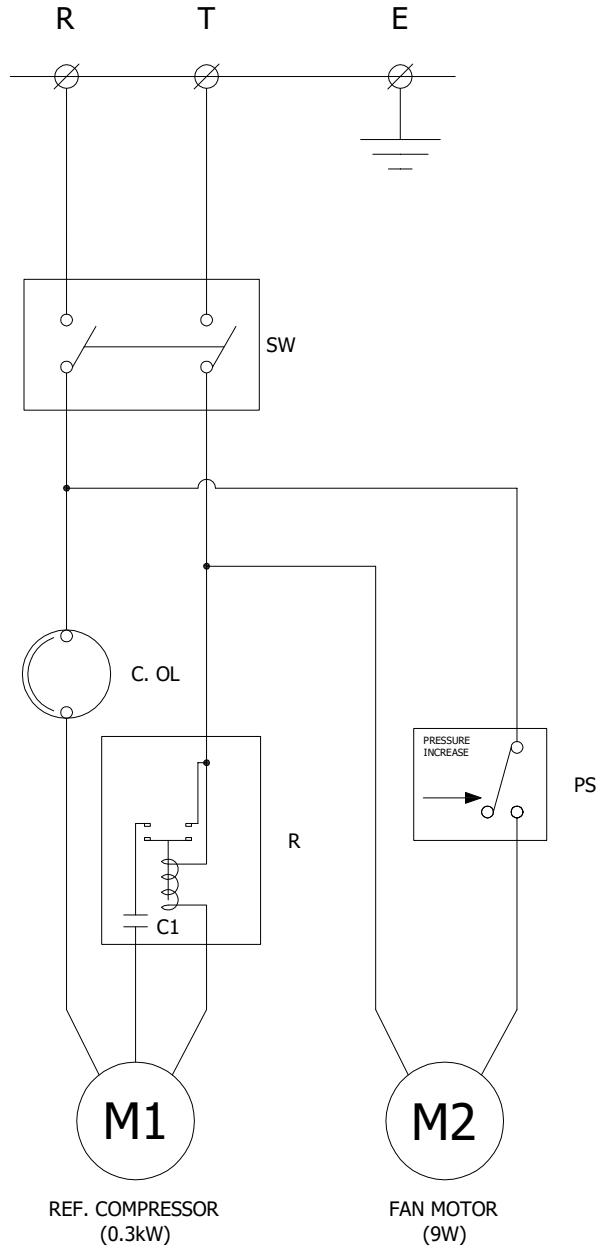

POWER SOURCE AC 220V, 1Ph, 60Hz		
NO.	SYMBOL	DESCRIPTION
7	PS	FAN CONTROLLER
6	C. OL	REF. COMPRESSOR OVERLOAD
5	SW	START SWITCH
4	C1	RUNNING CAPACITOR
3	R	RELAY
2	M2	FAN MOTOR
1	M1	REF. COMPRESSOR

△									
△									
△									
△									
△									
△	2018. 11. 26.	ISSUED FOR REFERENCE							
REV. NO.	DATE	DESCRIPTION	ENGR	CHK	APPD	APPD	APPD		
PROJECT									

MANUFACTURER		GSA <small>Global Standard Air & Gas</small>	
TITLE			
WIRING DRAWING			
ITEM NO.	HYD-7N	DWG NO.	REV.
SCALE	NONE	GSA-HYD-0007N-03	△