

	Refrigerated Air Dryer		Rev.	Date	Prepared By	Checked By	Approved By
			1	2021.04.27	LEE.G	JO.S.J.	KIM.H.W.
	Eco Pro Plus		2				
			3				
4							
Project Name		-	Model Name		HYD-15EP*		
SPECIFICATION							
1							
2	Supply Voltage	220V	Inlet Flow Rate	1.5	Nm ³ /min		
3	Phase	1PH	Inlet Pressure	7	barg		
4	Frequency	60Hz	Inlet Temp.	40	°C		
5	Control use	220V	Outlet Flow Rate	1.5	Nm ³ /min		
6	Fulid	Compressed Air	Outlet Pressure	6.5	barg		
7	Location	Indoor	Outlet Temp.	32±5	°C		
8	Design Code	Maker STD.	Pressure Drop (Element : Dry)	0.5	bar		
9	Area Class	Non-Hazardous	Outlet Dew Point	2~10	°C		
10			Design Pressure	9.7	barg		
11			Design Temperature	60	°C		
12			Ambient Temperature	32	°C		
CONSTRUCTION							
13							
14	Refrigerant	R-134A	Dimension (W x L x H)	424 X 823 X 1005	mm		
15	Ref. Compressor Type	Recipro Hemertic	Weight	50	kg		
16	Ref. Compressor Capacity	1/4 HP	Min. Power Consumption	0.2	kW		
17	Condenser Type	Air Cooled	Inlet Connection	25A	PT Female Screw		
18	Condenser Fan Motor	9 W	Outlet Connection	25A	PT Female Screw		
19		1 EA	Drain Connection	10A	PT Female Screw		
20	Condenser Fan Size	230 mm	Color (Munsell)	5.7PB 4.1/9.9			
21	Condenser Capacity	1/3 HP		5.7PB 2.9/3.5			
22	Condenser Material	Aluminum & Copper					
23	Heat Exchanger Type	Block					
24	Heat Exchanger Material	Aluminum					
25	Ref. Control Device	Capillary Tube					
26	ECO Mode Control	Dew Point Temp. Control					
27	Drain Trap Type	Auto Float					
STANDRAD FEATURES AND CONTROL							
28							
29	Fan Controller	YES	Ref. Compressor	YES			
30	Ref. Liquid Filter Dryer	YES	Capillary Tube	YES			
31	Overload Relay	NO	Hot Gas Bypass Valve	NO			
32	PCB Controller	YES	Air Cooled Condenser	YES			
33	Fan Motor Test Button	NO	Accumulator	NO			
34	Air Pressure Gauge	NO	Liquid Ref. Receiver	NO			
35	Ref. Pressure Gauge	NO	Pre-filter	YES			
36	High Pressure Switch	NO	Line-filter	YES			
37	Moisture Indicator	NO	After-filter	YES			
38	Drain	YES					
NOTES							
39							
40							
41							
42							
43							
44							
45							
46							

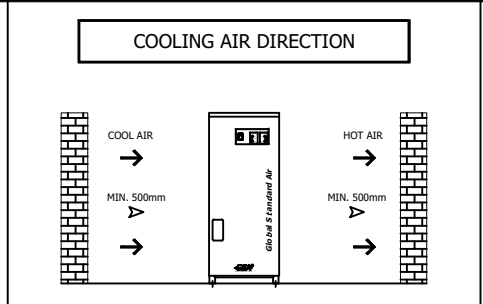

SPECIFICATION	
INLET AIR TEMPERATURE	40°C
AMBIENT TEMPERATURE	32°C
INLET AIR PRESSURE	7 barg
CAPACITY	1.5 Nm ³ /min
IN/OUT CONNECTION	PT 25A
DIMENSION(WXDXH, mm)	424 x 823 x 1005
WEIGHT	50 kg
MIN. POWER CONSUMPTION	0.2kW
POWER SUPPLY	220V - 1PH - 60Hz

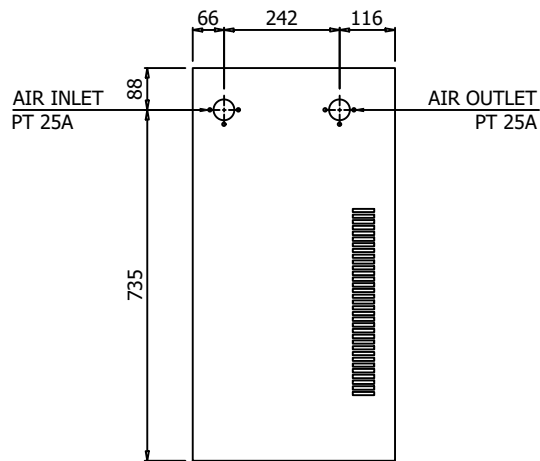

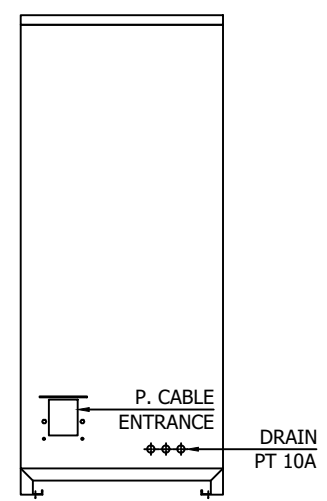
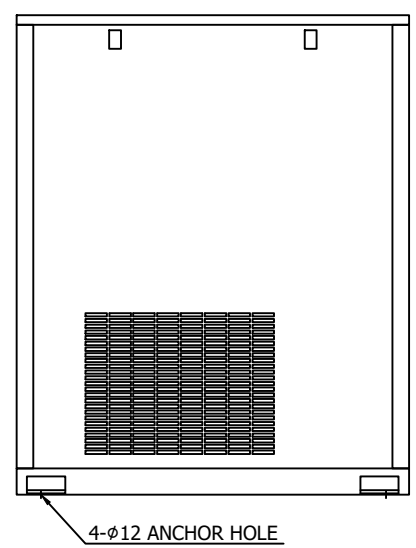
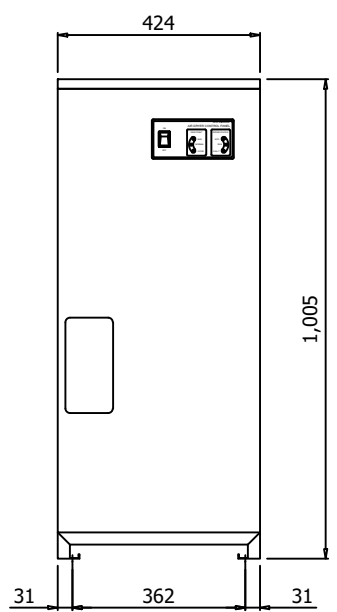
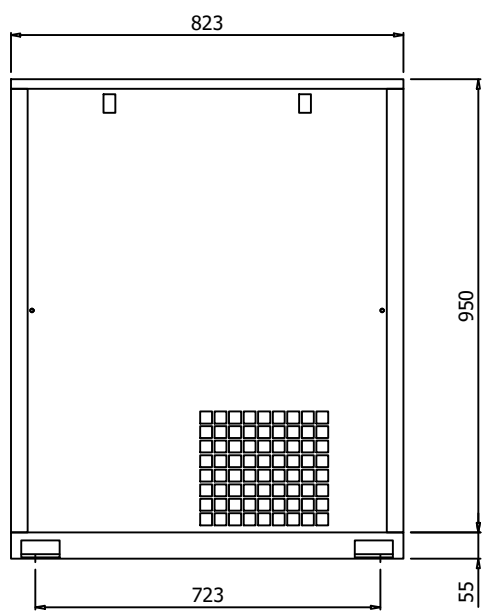

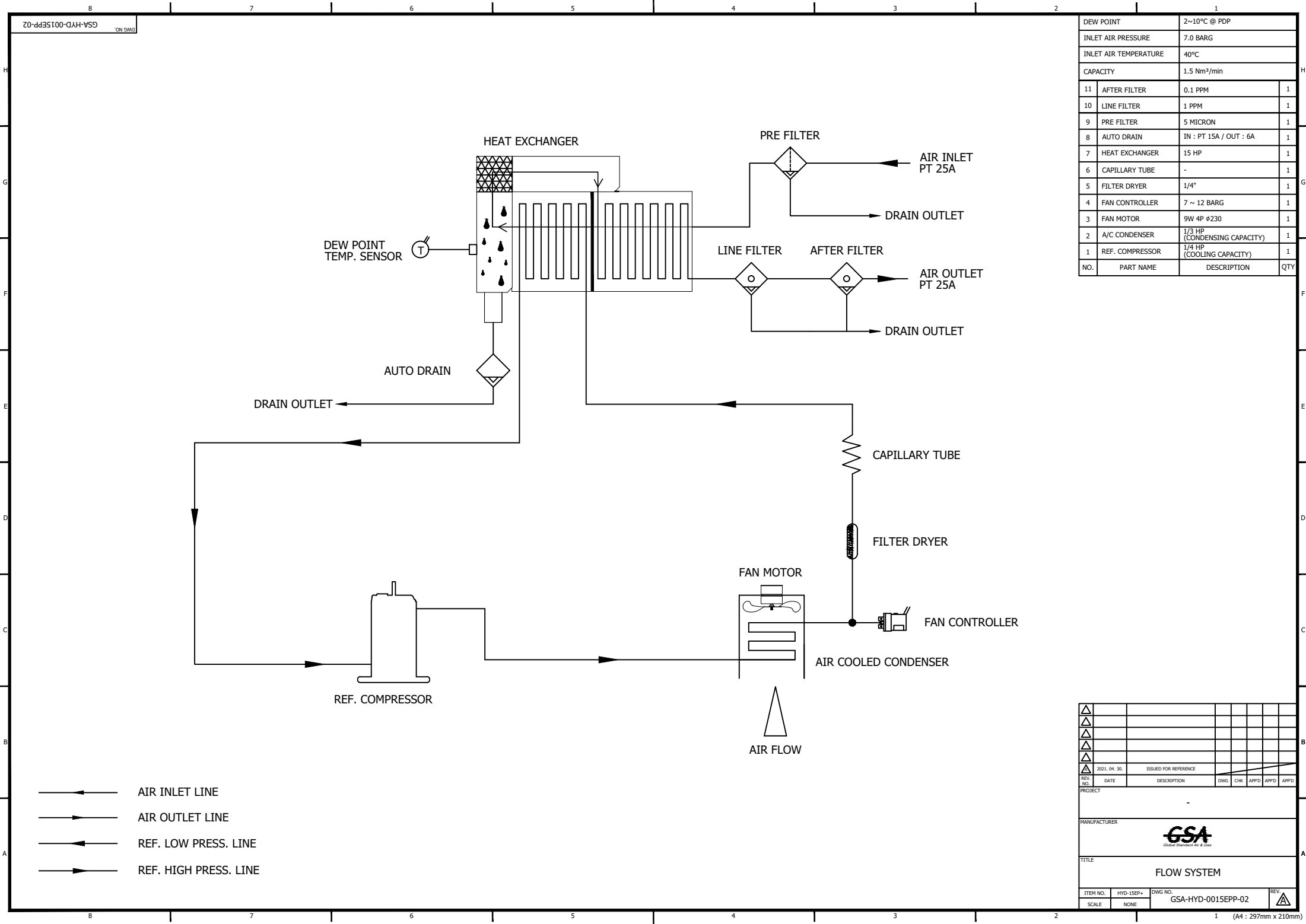

△										
△										
△										
△										
REV. NO.	DATE	DESCRIPTION	DWG	CHK	APPD	APPD	APPD	APPD	APPD	
2021. 04. 30.		ISSUED FOR REFERENCE								
PROJECT										
MANUFACTURER										
 Global Standard Air & Gas										
TITLE										
OUTLINE DRAWING										
ITEM NO.	HYD-1SEP+	DWG NO.	GSA-HYD-0015EPP-01							REV.
SCALE	NONE									△



DEW POINT	2~10°C @ PDP		
INLET AIR PRESSURE	7.0 BARG		
INLET AIR TEMPERATURE	40°C		
CAPACITY	1.5 Nm³/min		
11	AFTER FILTER	0.1 PPM	1
10	LINE FILTER	1 PPM	1
9	PRE FILTER	5 MICRON	1
8	AUTO DRAIN	IN : PT 15A / OUT : 6A	1
7	HEAT EXCHANGER	15 HP	1
6	CAPILLARY TUBE	-	1
5	FILTER DRYER	1/4"	1
4	FAN CONTROLLER	7 ~ 12 BARG	1
3	FAN MOTOR	9W 4P Ø230	1
2	A/C CONDENSER	1/3 HP (CONDENSING CAPACITY)	1
1	REF. COMPRESSOR	1/4 HP (COOLING CAPACITY)	1
NO.	PART NAME	DESCRIPTION	QTY

△										
△										
△										
△										
△	2021. 04. 30.	ISSUED FOR REFERENCE								
REV. NO.	DATE	DESCRIPTION	DWG	CHK	APPD	APPD	APPD	APPD	APPD	
PROJECT										
MANUFACTURER										
 <small>Global Systems of Air & Gas</small>										
TITLE										
FLOW SYSTEM										
ITEM NO.	HYD-1SEP+	DWG NO.	GSA-HYD-0015EPP-02							REV.
SCALE	NONE									△

 AIR INLET LINE
 AIR OUTLET LINE
 REF. LOW PRESS. LINE
 REF. HIGH PRESS. LINE

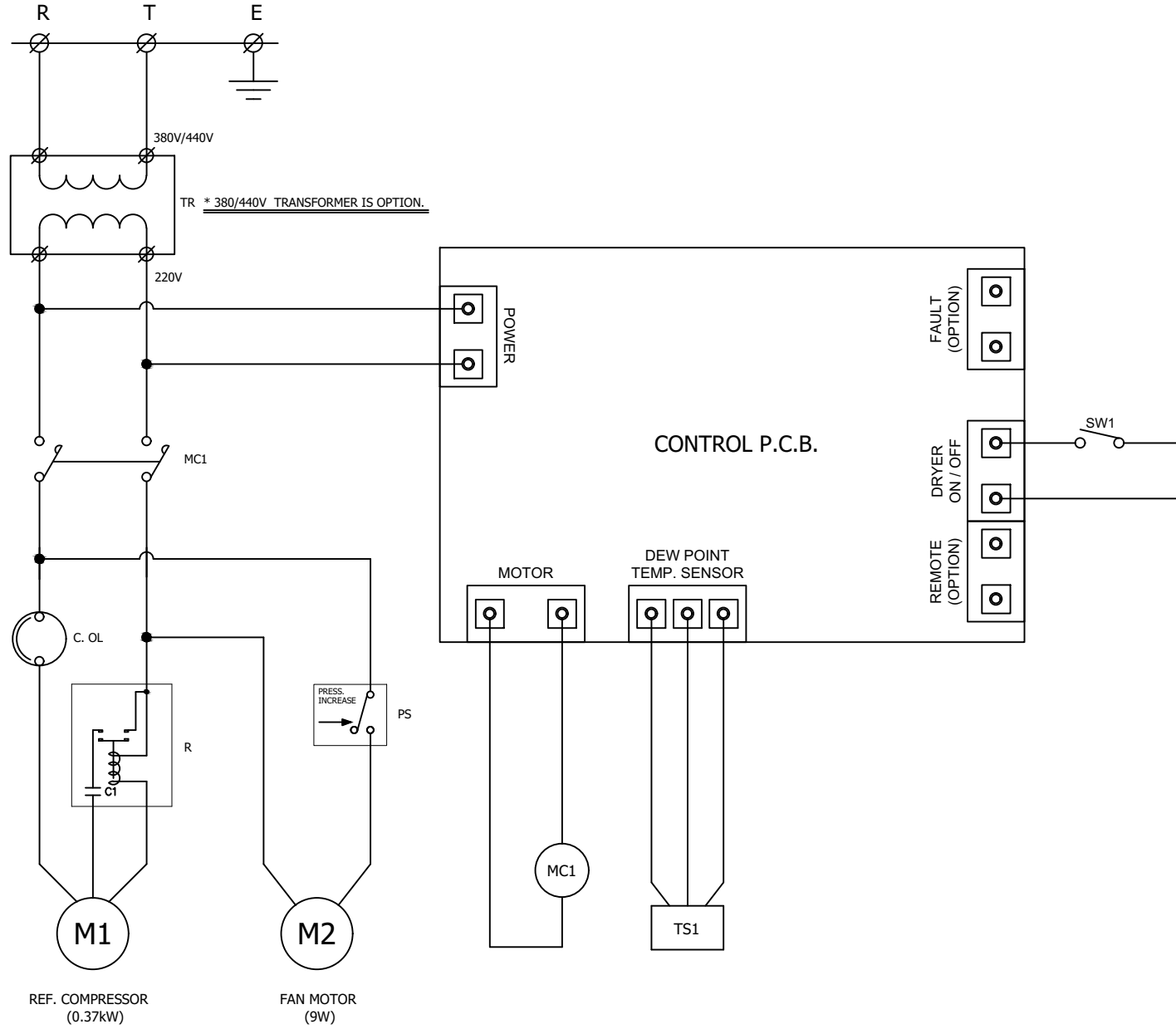

POWER SOURCE
AC 220V, 1Ph, 60Hz

10	SW1	DRYER ON/OFF SWITCH
9	TR	TRANSFORMER
8	TS1	DEW POINT TEMP. SENSOR
7	PS	FAN CONTROLLER
6	C. OL	REF. COMPRESSOR OVERLOAD
5	C1	RUNNING CAPACITOR
4	R	RELAY
3	MC1	MAGNETIC CONTACTOR
2	M2	FAN MOTOR
1	M1	REF. COMPRESSOR
NO.	SYMBOL	DESCRIPTION

△										
△										
△										
△										
△										
REV. NO.	DATE	DESCRIPTION	DWG	CHK	APPD	APPD	APPD	APPD	APPD	
2021. 04. 30.		ISSUED FOR REFERENCE								
PROJECT										
-										
MANUFACTURER										
 <small>Globe Service of Air & Gas</small>										
TITLE										
WIRING										
ITEM NO.	HYD-1SEP+	DWG NO.	GSA-HYD-0015EPP-03							REV.
SCALE	NONE									△